

KR series

Power rocker switches

Distinctive features

Attractive rugged rocker switch

UG1410A-R2

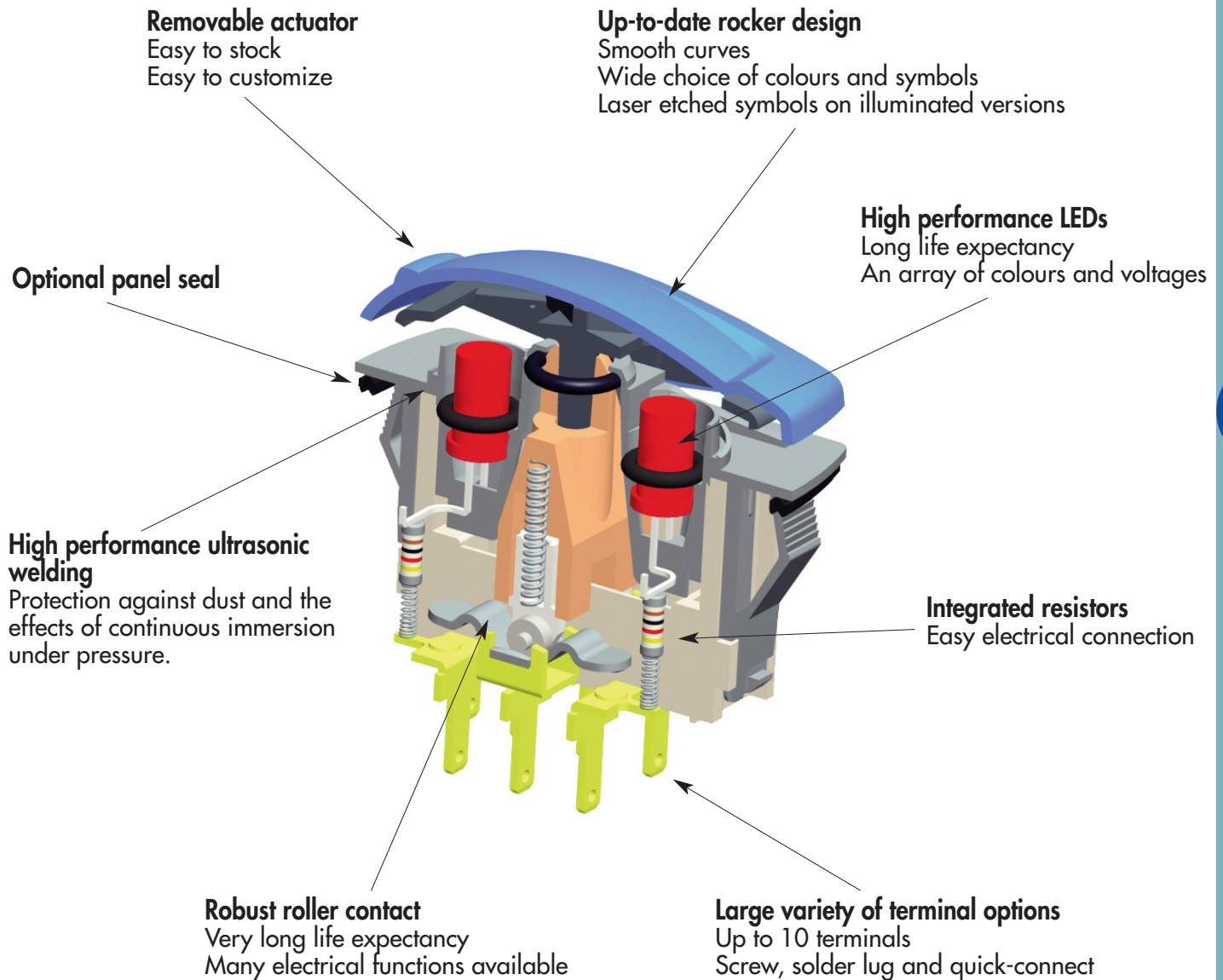

APEM will be happy to develop custom product solutions. Please contact us with your requirements.

The company reserves the right to change specifications without notice.

KR series

Power rocker switches

Specifications



- Unique rocker design
- Wide choice of colours
- Laser etched symbols
- Illuminated or non-illuminated
- Optionally sealed to IP68 or IP69K

ELECTRICAL SPECIFICATIONS

- Current/voltage rating with resistive load :
 - Silver plated contacts :
 - A** : 5A 24VDC, 100.000 cycles - 10A 24VDC, 10.000 cycles (terminals 6.35 x 0.8 only)
 - S** : 20A 12V, 10.000 cycles (see Overview)
 - Gold plated contacts (D) : 20mA 12V, 150.000 cycles
- Current/voltage rating with lamp load - silver contacts (A) :
 - functions 1 & 6 : 100W 24VDC, 10.000 cycles
 - other functions : 60W 24VDC, 10.000 cycles
- Initial contact resistance : 10 mΩ max.
- Insulation resistance : 1.000 MΩ min. at 500VDC
- Dielectric strength : 2.000 Vrms 50 Hz min. between terminals
- Mechanical life : 150.000 cycles min.

MATERIALS

- Case : PA 6-6
- Actuator : ABS
- Bezel : PA 6-6
- Contacts & terminals : brass, solid silver grain, silver plated (**A or S**) or brass, solid silver grain, gold plated (**D**)
- Contact roller : brass, nickel plated

SEALING

Sealing is optional.
To order a sealed product, complete the appropriate box of ordering format on the following pages.

ENVIRONMENTAL SPECIFICATIONS

- Sealing options :
 - K : IP68 to front panel components of switch only according to IEC 60529
 - Z : IP69K panel sealing according to DIN 40050-9
- Salt spray resistance : 96 hours according to IEC 512-6, test 11f
- Vibration resistance : 10-500 Hz / 10 g per IEC 60068-2-6
- Operating temperature : -40°C to +85°C

DIMENSIONS

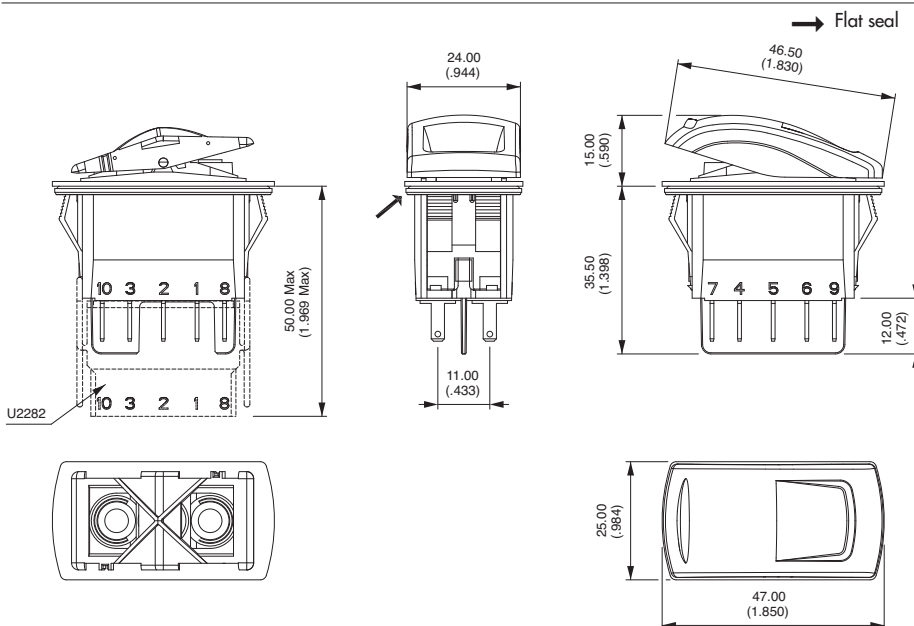

Packaging unit : 40 pieces

Dimensions : First dimensions are in mm while inches are shown as bracketed numbers.

KR series

Power rocker switches

Overview

HOW TO ORDER

- To order a complete product, fill in all the boxes of the following order guide.
- To order case only (without actuator), finish your order number with the LED wiring code.
- To order actuator only (without case), begin the order number with code KRR, then follow the order format from "actuator type" until the end of the options.

CASE + LEDS

KR						Side A	Side B																																																																																
SERIES	Electrical functions		Contacts		Sealing		LEDS																																																																																
Poles	<table border="0"> <tr><td>1</td><td>ON</td><td>-</td><td>OFF</td></tr> <tr><td>4</td><td>ON</td><td>ON</td><td>ON</td></tr> <tr><td>4-1R</td><td>ON</td><td>ON</td><td>MOM</td></tr> <tr><td>5</td><td>MOM</td><td>-</td><td>ON</td></tr> <tr><td>6</td><td>ON</td><td>-</td><td>ON</td></tr> <tr><td>7</td><td>MOM</td><td>OFF</td><td>MOM</td></tr> <tr><td>8</td><td>ON</td><td>OFF</td><td>MOM</td></tr> <tr><td>9</td><td>ON</td><td>OFF</td><td>ON</td></tr> </table> <p>Function 1 only for 6-terminal versions.</p>		1	ON	-	OFF	4	ON	ON	ON	4-1R	ON	ON	MOM	5	MOM	-	ON	6	ON	-	ON	7	MOM	OFF	MOM	8	ON	OFF	MOM	9	ON	OFF	ON	<table border="0"> <tr><td>A</td><td>Silver</td></tr> <tr><td>D</td><td>Gold plated</td></tr> <tr><td>S</td><td>Silver 20A ***</td></tr> </table>		A	Silver	D	Gold plated	S	Silver 20A ***	<table border="0"> <tr><td>X</td><td>No</td></tr> <tr><td>K</td><td>IP68</td></tr> <tr><td>Z</td><td>IP69K</td></tr> </table>		X	No	K	IP68	Z	IP69K	<table border="0"> <tr><td>X</td><td>None</td></tr> <tr><td>A</td><td>LED 6V red</td></tr> <tr><td>B</td><td>LED 6V green</td></tr> <tr><td>C</td><td>LED 6V yellow</td></tr> <tr><td>M</td><td>LED 6V blue</td></tr> <tr><td>R</td><td>LED 6V white</td></tr> <tr><td>D</td><td>LED 12V red</td></tr> <tr><td>E</td><td>LED 12V green</td></tr> <tr><td>F</td><td>LED 12V yellow</td></tr> <tr><td>N</td><td>LED 12V blue</td></tr> <tr><td>S</td><td>LED 12V white</td></tr> <tr><td>J</td><td>LED 24V red</td></tr> <tr><td>K</td><td>LED 24V green</td></tr> <tr><td>L</td><td>LED 24V yellow</td></tr> <tr><td>P</td><td>LED 24V blue</td></tr> <tr><td>T</td><td>LED 24V white</td></tr> <tr><td>...</td><td></td></tr> </table>		X	None	A	LED 6V red	B	LED 6V green	C	LED 6V yellow	M	LED 6V blue	R	LED 6V white	D	LED 12V red	E	LED 12V green	F	LED 12V yellow	N	LED 12V blue	S	LED 12V white	J	LED 24V red	K	LED 24V green	L	LED 24V yellow	P	LED 24V blue	T	LED 24V white	...		Wiring
1	ON	-	OFF																																																																																				
4	ON	ON	ON																																																																																				
4-1R	ON	ON	MOM																																																																																				
5	MOM	-	ON																																																																																				
6	ON	-	ON																																																																																				
7	MOM	OFF	MOM																																																																																				
8	ON	OFF	MOM																																																																																				
9	ON	OFF	ON																																																																																				
A	Silver																																																																																						
D	Gold plated																																																																																						
S	Silver 20A ***																																																																																						
X	No																																																																																						
K	IP68																																																																																						
Z	IP69K																																																																																						
X	None																																																																																						
A	LED 6V red																																																																																						
B	LED 6V green																																																																																						
C	LED 6V yellow																																																																																						
M	LED 6V blue																																																																																						
R	LED 6V white																																																																																						
D	LED 12V red																																																																																						
E	LED 12V green																																																																																						
F	LED 12V yellow																																																																																						
N	LED 12V blue																																																																																						
S	LED 12V white																																																																																						
J	LED 24V red																																																																																						
K	LED 24V green																																																																																						
L	LED 24V yellow																																																																																						
P	LED 24V blue																																																																																						
T	LED 24V white																																																																																						
...																																																																																							
<table border="0"> <tr><td>3</td><td>Single pole</td></tr> <tr><td>4</td><td>Double pole</td></tr> </table>	3	Single pole	4	Double pole			<table border="0"> <tr><td>Terminals</td><td>Terminals (continued)</td></tr> <tr><td>Screw</td><td>5 6 terminals w/o barrier</td></tr> <tr><td>0 6 terminals with barrier</td><td>D 10 term. with barrier</td></tr> <tr><td>Solder lug/quick-connect</td><td>E 10 term. w/o barrier</td></tr> <tr><td>2 6 terminals with barrier</td><td>F 10 term. for use with connector U2292</td></tr> <tr><td>4 6 terminals w/o barrier</td><td>Normalized quick-connect</td></tr> <tr><td>A 10 term. with barrier</td><td>2,8x0,8</td></tr> <tr><td>B 10 term. w/o barrier</td><td>G 10 term. with barrier</td></tr> <tr><td>C 10 terminals for use with connector U2292</td><td>H 10 term. w/o barrier</td></tr> <tr><td>Normalized quick-connect</td><td>J 10 terminals for use with connector U2282</td></tr> <tr><td>6,35x0,8</td><td></td></tr> <tr><td>3 6 terminals with barrier</td><td></td></tr> </table>		Terminals	Terminals (continued)	Screw	5 6 terminals w/o barrier	0 6 terminals with barrier	D 10 term. with barrier	Solder lug/quick-connect	E 10 term. w/o barrier	2 6 terminals with barrier	F 10 term. for use with connector U2292	4 6 terminals w/o barrier	Normalized quick-connect	A 10 term. with barrier	2,8x0,8	B 10 term. w/o barrier	G 10 term. with barrier	C 10 terminals for use with connector U2292	H 10 term. w/o barrier	Normalized quick-connect	J 10 terminals for use with connector U2282	6,35x0,8		3 6 terminals with barrier				See following pages.																																																				
3	Single pole																																																																																						
4	Double pole																																																																																						
Terminals	Terminals (continued)																																																																																						
Screw	5 6 terminals w/o barrier																																																																																						
0 6 terminals with barrier	D 10 term. with barrier																																																																																						
Solder lug/quick-connect	E 10 term. w/o barrier																																																																																						
2 6 terminals with barrier	F 10 term. for use with connector U2292																																																																																						
4 6 terminals w/o barrier	Normalized quick-connect																																																																																						
A 10 term. with barrier	2,8x0,8																																																																																						
B 10 term. w/o barrier	G 10 term. with barrier																																																																																						
C 10 terminals for use with connector U2292	H 10 term. w/o barrier																																																																																						
Normalized quick-connect	J 10 terminals for use with connector U2282																																																																																						
6,35x0,8																																																																																							
3 6 terminals with barrier																																																																																							

*** S contacts for all functions except 5 and 4-1R - for normalized quick-connect terminals 6,35x0,8 only.

ACTUATOR

Type	Colour																								
<table border="0"> <tr><td>1</td><td>For non-illuminated application</td></tr> <tr><td>2</td><td>For illuminated application</td></tr> </table>	1	For non-illuminated application	2	For illuminated application	<table border="0"> <tr><td>1</td><td>Blue</td></tr> <tr><td>1/4</td><td>Dark blue</td></tr> <tr><td>2</td><td>Black</td></tr> <tr><td>3</td><td>Green</td></tr> <tr><td>4</td><td>Grey</td></tr> <tr><td>5</td><td>Yellow</td></tr> <tr><td>6</td><td>Red</td></tr> <tr><td>7</td><td>Ivory</td></tr> <tr><td>9</td><td>Orange</td></tr> <tr><td>A</td><td>Aluminium bright</td></tr> </table>	1	Blue	1/4	Dark blue	2	Black	3	Green	4	Grey	5	Yellow	6	Red	7	Ivory	9	Orange	A	Aluminium bright
1	For non-illuminated application																								
2	For illuminated application																								
1	Blue																								
1/4	Dark blue																								
2	Black																								
3	Green																								
4	Grey																								
5	Yellow																								
6	Red																								
7	Ivory																								
9	Orange																								
A	Aluminium bright																								

ACTUATOR MARKING

	Area A	Area M	Area B									
Orientation	Symbols											
<table border="0"> <tr><td>N</td><td></td></tr> <tr><td>O</td><td></td></tr> <tr><td>S</td><td></td></tr> <tr><td>E</td><td></td></tr> </table>	N		O		S		E		<table border="0"> <tr><td></td></tr> </table>			
N												
O												
S												
E												

Symbols & Accessories : see end of section D.



NOTICE : please note that not all combinations of above numbers are available. Refer to the following pages for further information.

KR series

Power rocker switches

Case

- To order case only (without rocker), finish your order number with the LED wiring code.

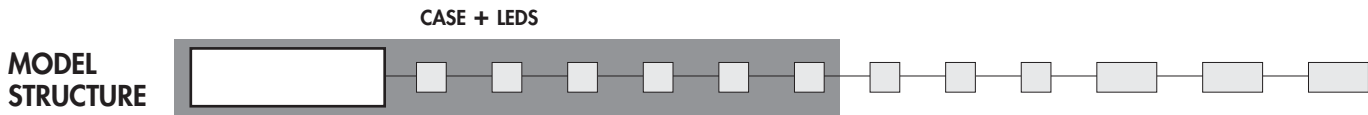

	2-3	1-2
Single pole	5-6	4-5
KR31	ON	OFF
KR35	MOM	ON
KR36	ON	ON
KR37	MOM	OFF
KR38	ON	OFF
KR39	ON	OFF
Double pole		
KR41	ON	ON
KR44*	ON	ON
KR44-1R*	ON	MOM
KR45	MOM	ON
KR46	ON	ON
KR47	MOM	OFF
KR48	ON	OFF
KR49	ON	OFF

Bottom view

10 terminal version

6 terminal version

* Function 4 : single pole in double pole case

D

ELECTRICAL FUNCTIONS AND CONNECTIONS

In the tables below, terminal connections as viewed from bottom of switch.

Only the contact area is represented.

For single pole models, only terminals 1, 2 and 3 are to be considered (not terminals 6, 5, 4).

x = w/o terminal

o = with terminal

▲ = momentary

	Positions		
Function 1 * KR31-KR41			
Function 5 KR35-KR45			
Function 6 KR36-KR46			
Function 7 KR37-KR47			
Function 8 KR38-KR48			
Function 9 KR39-KR49			
Function 4 KR44			
Function 4-1R KR44-1R			

* Function 1 only available for 6 terminal versions.

KR series

Power rocker switches

Case

TERMINALS

CASE + LEDS



Screw

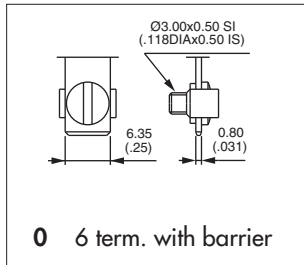

Solder lug / quick-connect

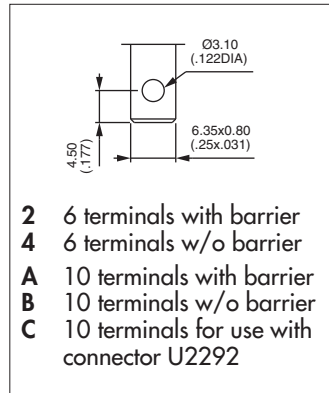

Normalized quick-connect 6,35x0,8

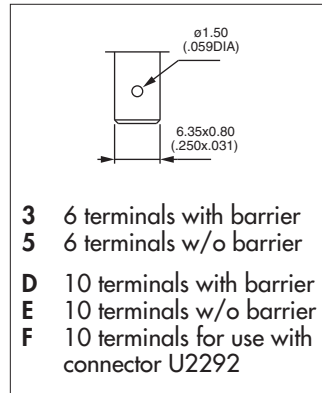

Normalized quick-connect 2,8x0,8

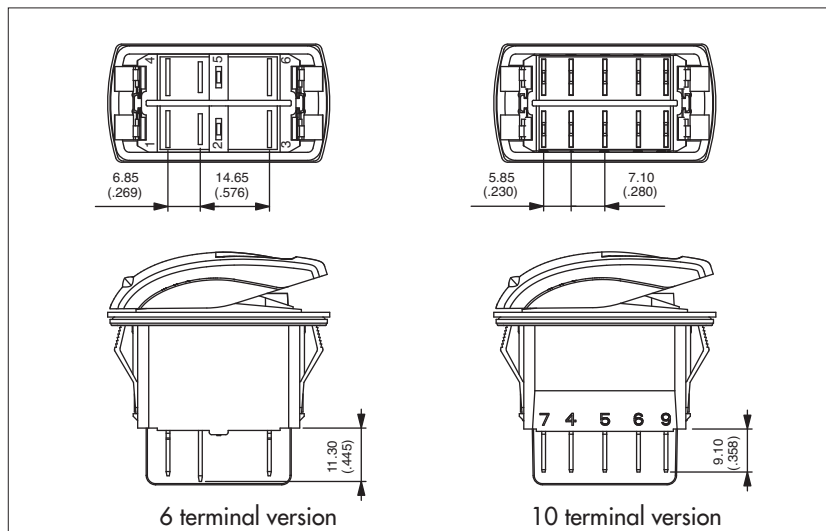
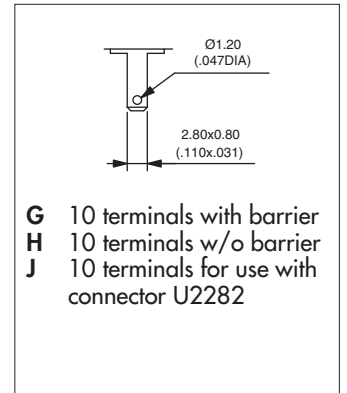

Terminals are marked on the case.

The drawings show the maximum possible number of terminals.

D

CONTACT MATERIALS

CASE + LEDS



- A** Silver
- D** Silver, gold plated
- S** Silver 20A **NEW!**
For all functions except 5 and 4-1R - for normalized quick-connect terminals 6,35x0,8 only.

KR series

Power rocker switches

Case - LEDs

SEALING

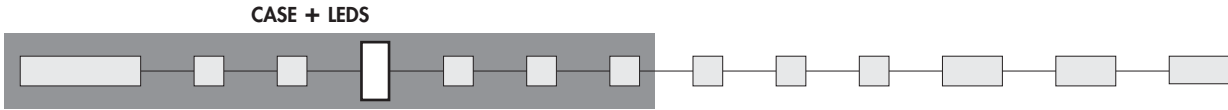

- X** No sealing
- K** IP68 (front panel components of switch only)
- Z** IP69K - Installation notice available on request

Ultrasonic welding of frame to case is standard on all versions.
The ultrasonic welding and the optional panel seal prevent water and dust from introducing into the switch housing.

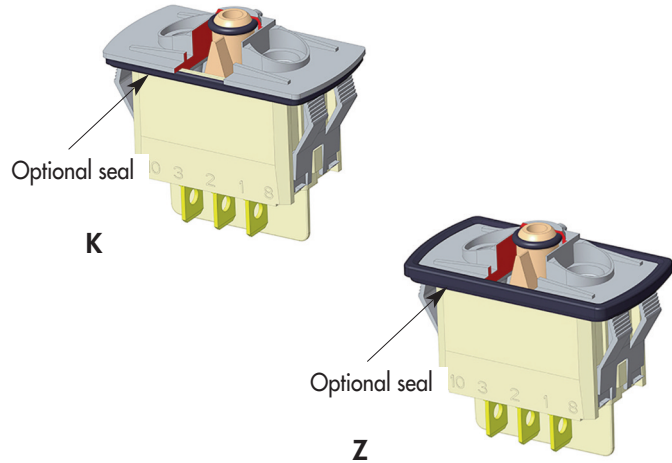

D

LEDS

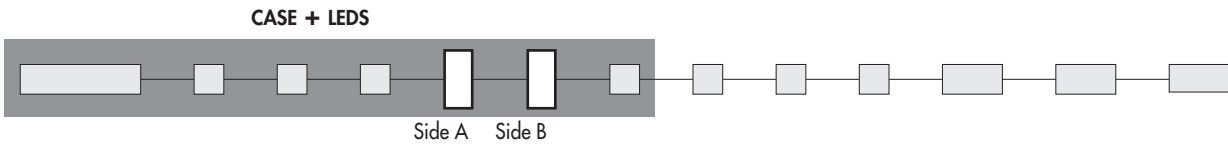

Complete each enlarged box with one of the codes listed below.

- X** Without LED

	Red	Green	Yellow	Blue	White	Red/green
6VDC	A	B	C	M	R	1
12VDC	D	E	F	N	S	2
24VDC	J	K	L	P	T	3
No resistor	U	V	W	Y	Z	-

LED consumption : 20mA @ nominal voltage (25°C)
Other illumination solutions : on request.

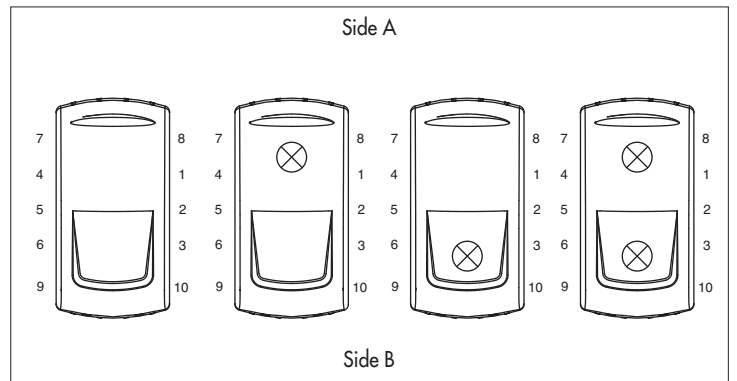

KR series

Power rocker switches

Case - LEDs

WIRING

The LED wiring diagram is shown on the case.

CASE + LEDs

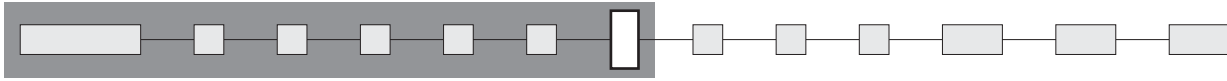

• For 6 terminal versions

LED connected to the load

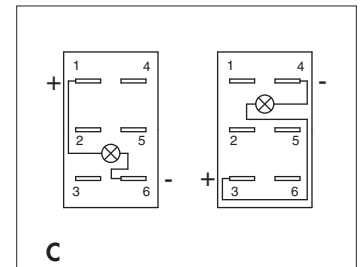
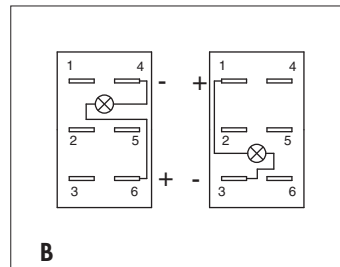
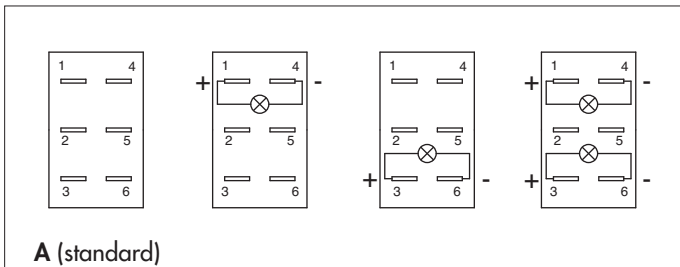

Note : If not available, terminals are added to connect the LED.

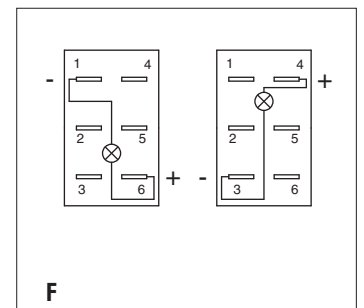
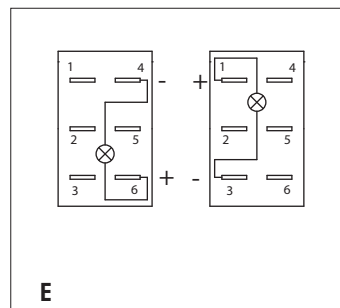
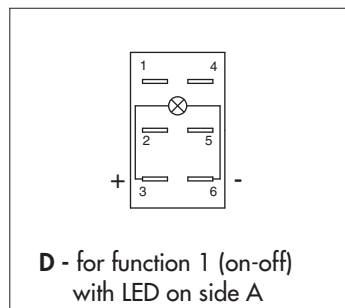

• For 10 terminal versions

Independent LED or integrated functions

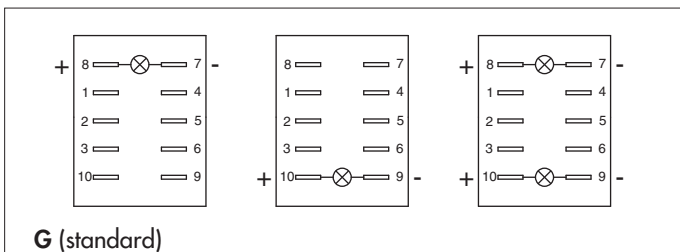

To have independent LEDs.

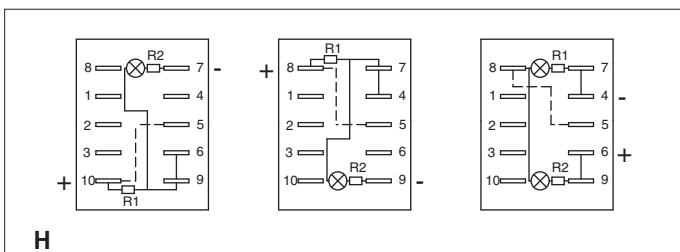

To obtain 2 symbol illumination levels (night illumination when OFF and higher illumination when ON).

H wiring with LED on side A available with functions 6, 8, 9 and 44.

H wiring with LED on side B available with functions 5, 6 and 9.

H wiring with 2 LEDs available with functions 8 and 9.

More information (H wiring schematics) : on request.

Dotted line = external wiring, continuous line = internal wiring

Available in Single Pole only, with H and J quick-connect terminals.

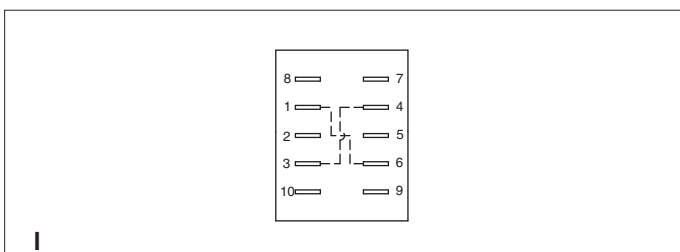

To have a polarity inversion (typical application : fan motor).

Dotted line = external wiring

Power supply between 2 and 5 - Load between 1 and 4 or 3 and 6. Available with H and J quick-connect terminals.

Please contact us for other wiring solutions.

KR series

Power rocker switches

Actuator - Marking

To order actuator only (without case), begin the order number with code KRR, then follow the order format from "actuator type" until the end of the options.

ACTUATOR TYPE

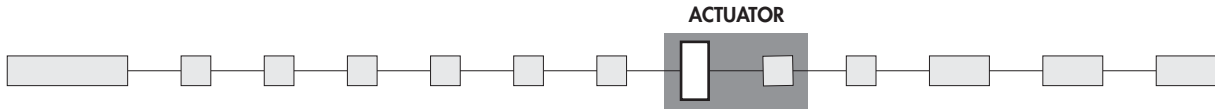

- 1 For non-illuminated application
- 2 For illuminated application

Other rocker design : on request.

ACTUATOR COLOUR

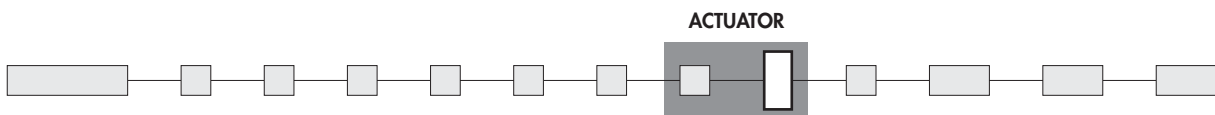

Code	Colour
1	Blue
1/4	Dark blue
2	Black
3	Green

Code	Colour
4	Grey
5	Yellow
6	Red
7	Ivory

Code	Colour
7/1	White
9	Orange
A	Aluminium bright

Note : colours 7 and 7/1 not available on illuminated versions.

A **soft-touch varnish** can be added. Consult us.



MARKING ORIENTATION

If no marking required, complete the box with code N.

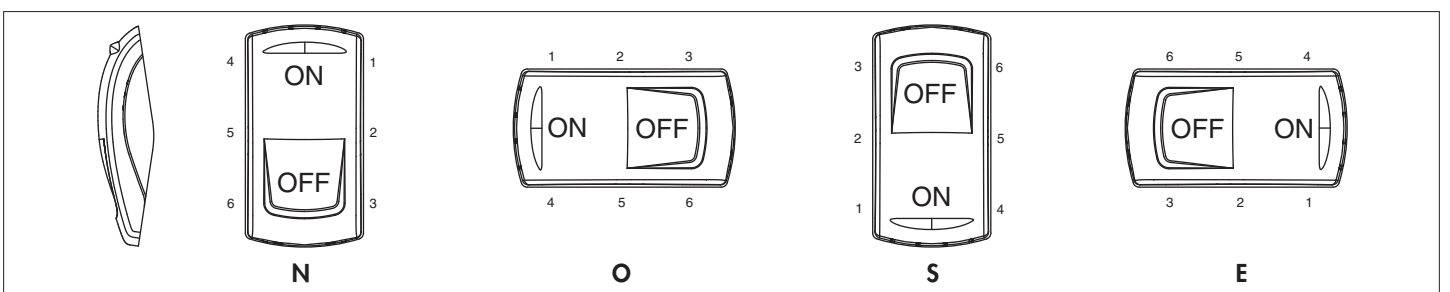
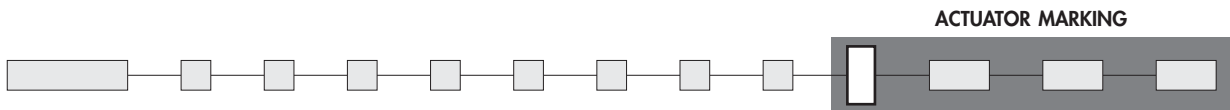

Other orientations : on request

KR series

Power rocker switches

Marking - Mounting

SYMBOLS

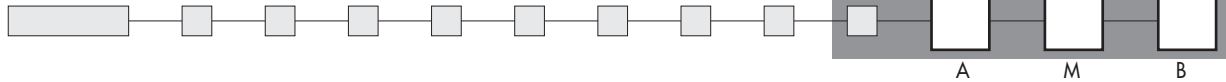

ACTUATOR MARKING

A M B

XX No symbol

Available symbols : see end of section D.

Marking colour

White marking for illuminated rockers (laser etching) and non-illuminated black rockers (pad printing). Black marking for non-illuminated colour rockers (pad printing). Other : on request.

Laser etching resistance

- Water and petrol resistant according to EN61058-1
- Tear resistant (cross-cut test) according to NF ISO 2409 : class 0
- UV resistant according to ISO 4892-2

Marking area

For illuminated versions. The symbol will be included in the hatched area. Marking in M area : on request.

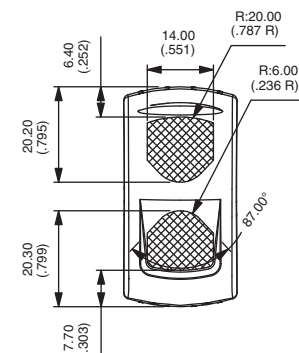
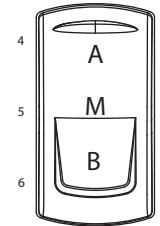

MATRIX MOUNTING

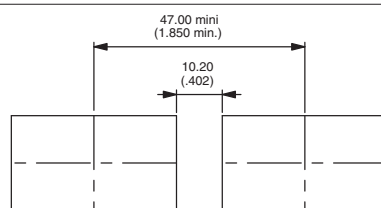
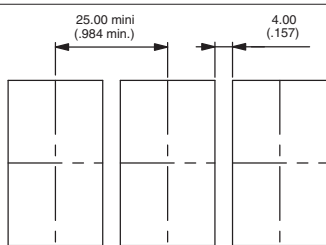

SWITCH PANEL CUT-OUT

Panel thickness : 0,8 mm to 4,6 mm

Recommended panel thickness : between 2 mm and 3,5 mm

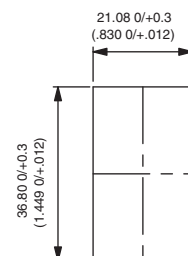

SPECIFIC MATRIX MOUNTING FOR Z VERSION

